

Service Booklet
Service-Handbuch

Scrubmaster B 120 R
(7177.XX)

Schulung/Training
Fehlersuche/Troubleshooting
Einstelldaten/Adjustments



Table of contents

1	Information	6
2	General information	7
	2.1 Settings	10
	2.1.1 Connecting to the diagnostics PC	12
	2.1.2 Flashing the control unit	14
	2.1.3 Connection diagram	16
	2.2 Brief description	17
	2.2.1 Switching off vacuuming / dirt water tank full	18
	2.2.2 Indication Solution Tank empty	21
	2.2.3 Machine home position	22
	2.2.4 Seat contact switch (3.6.6.4.)	23
	2.2.5 Accessing programming	25
	2.2.6 Resetting the last service message in the switch-on menu	29
3	Technical data	30

Table of contents

4	Maintenance intervals	35
	4.1 Hako system maintenance (customer)	36
	4.2 Hako system maintenance I	37
	4.3 Hako system maintenance II	39
	4.4 Hako system maintenance S	40
5	Cleaning programmes (FPV)	41
	5.1 SOW Cleaning Program	44
6	Machine settings	46
	6.1 Basic settings	46
	6.1.1 Cleaning units	47
	6.1.2 Battery and charger settings	49
	6.1.3 Battery setting (LDS)	50
	6.1.4 Charger	52
	6.1.5 Charger characteristic curves	54
	6.1.6.Charging characteristics table of the integrated charger	55
	6.2 Customer-specific settings (PPV)	56

Table of contents

7	Mechanical components	60
	7.1 Squeegee	60
	7.2 Rotating brush heads	65
	7.3 Roller brush heads	65
	7.4 Lifting element brush head	66
	7.4.1 Potentiometer in the lifting element for the brush head	67
8	Water pump	68
	8.1 Water quantities	69
	8.2 Water pump standstill detection	70
	8.3 Speed depending water amount reduction	71
9	Drive	72
	9.1 DMC drive control (AC motor)	73
	9.1.1 Connection description	74
	9.2 Service codes DMC control unit	75
	9.3 Brake – manual release of the brake	80
	9.4 Brake – testing the brake function	81

Table of contents

10	Service messages	82
	10.1 Service alarm clock 3.3.1.1	87
11	Battery charger	88
	11.1 Operating manual	88
	11.2 Programming the charger	92
	11.3 Charge data table	93
12	Options	94
13	Real-time clock (RTC)	97
14	Notes	100

1. Information

Caution:

- During all work at the machine, secure it against unintentional movement.
- Only carry out work at the machine when it has been de-energised (disconnect the battery plug), except for current and voltage measurements.
- After repairing electrical drives, measure the starting and operating currents to detect possibly still present errors.
- During all work at the machine, always observe the general safety and accident prevention regulations of the legislation.

2. General information

The Scrubmaster B120 R is equipped with a service indicator in the display of the operating hours meter. When switching on the key switch, four digits are shown on the display for approx. 3 seconds that state the software version (e.g. 1.004), and possibly further four digits that show the last displayed service message, followed by the hour indicator.

If a fault occurs, the wrench in the display lights up and the machine beeps. The current **service code** (four-digit alphanumerical code in the service indicator) is shown **with flashing dots between the characters**.

It is only a current service message if these criteria apply!

2. General information

Scrubmaster B120 R

The Scrubmaster B120 R is available in working widths of between 70 cm and 90 cm.

The machines are always supplied ex factory with batteries; here, it is possible to choose between various battery sizes (from 180 Ah to 320 Ah) as well as between different battery technologies (EPzS/EPzB, PzV or GiV).

Furthermore, it is differentiated between edition machines and configuration machines. Edition machines are machines that have a clearly defined scope of equipment. In this context, only a limited scope of additional equipment features is available. Additional options are not installed in the factory but supplied loosely with the delivery for on-site installation at the customer's premises.

A separate operating manual, which describes the operating and service statuses of the charger, is available for the chargers and supplied together with the device. The charge indicator is shown on the machine display. Service messages of the charger are also shown on the machine display.

2. General information

Configuration machines are manufactured order-specifically according to customer wishes from a pool of available equipment features. Additional options (chemical dosing, working light, warning signal, etc.) are installed in the factory. For more details, see the relevant current price lists.

Matrix for a ready-for-use machine

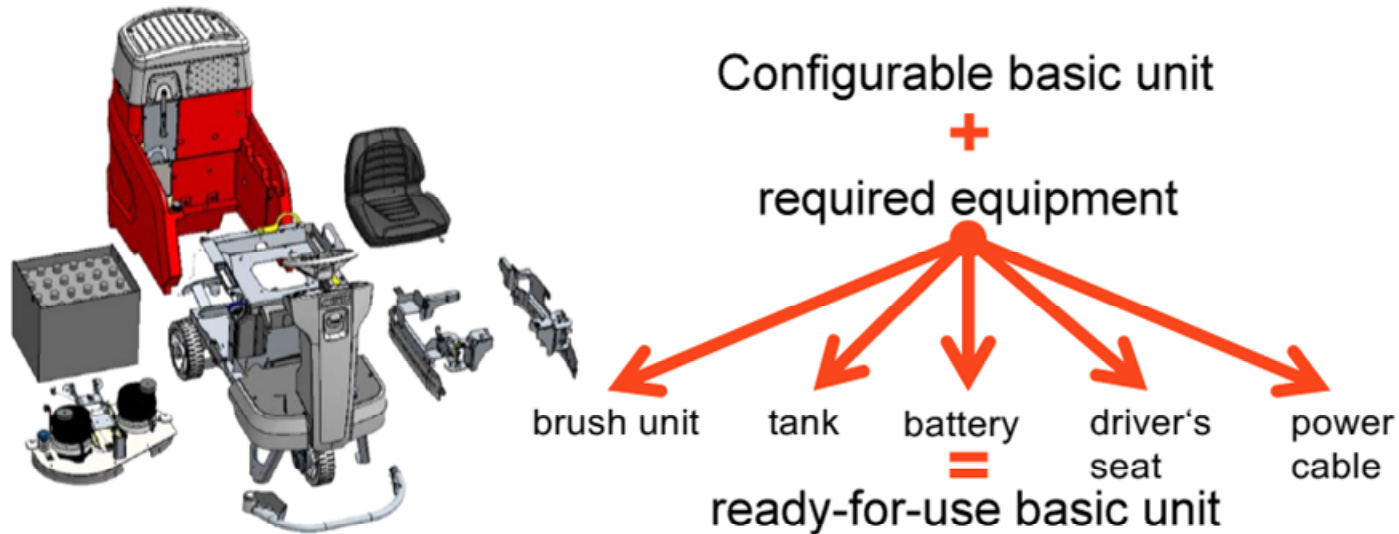

2.1 Settings

Respective settings can be carried out via the machine's configuration menu. Currently, these settings are carried out via the machine display. The diagnostics plug (order no. PN 03006790) is required for these settings. Setting via the diagnostics system is planned but currently not yet available.

Settable parameters include:

- Cleaning unit
- LDS (Low Discharge Signal sender) / Battery type
- Charger
- Options
- Deleting the display of the last error after repair work
- Programmable programme variants (PPV)
- Fixed programme variants (FPV), cleaning programmes

2.1 Settings

A new machine control unit is supplied without machine software ex spare parts warehouse. This is indicated by the service code 4.5.2.5 after installing the central control unit and switching on the key switch in the machine's operating hours meter. This service code is generated direct from the display control board. Only the boot loader has already been pre-installed, but not yet the machine-specific software.

Therefore, the machine software must be “flashed” onto the central control unit after mechanical installation and electrical connection of the central control unit.

- Service PC on which the current HAKO diagnostics software is installed.
(Windows 10)
- 1 free USB 2.0 port
- CAN-FOX interface PN 03502430
- Alternatively, CANUSB interface PN 03501750
- Interface cable PN 03502750

2.1.1 Connecting to the diagnostics PC

The following components are required to activate the control unit of the Scrubmaster B120 R after a replacement:

- Current Hako diagnostics software (via the Hako WebX download portal)
- Service PC (e.g. Panasonic CF20 / FZ55)
- Interface PN 03502430* (recommended interface) or, alternatively: PN 03501750 **
- Diagnostics cable PN 03502750
- Diagnostics plug PN 03006790

See Chapter 2.1.3 for connections to the recommended interface.

2.1.1 Connecting to the diagnostics PC

Download the “HakoDiagnostics” software as a zip file or as a folder from the Hako WebX download area.

Information on accessing the download server can be requested from Christin Ramm
e-mail: cramm@hako.com

To install the software on a service computer or for Updating it:

Follow the instructions in the HakoDiagnose MainSetup Guide, delivered with the Diagnosis software.

2.1.2 Flashing the control unit

- Install the control unit –A01 fully in the machine, activate the backup battery. To do so, remove the insulating strip between the battery (CR2032) and the battery holder on the rear of the control unit.
- Connect the interface (* / **) to a free USB port of the service PC.
- Establish a connection between the central control unit and the service PC using the diagnostics cable (PN 03502750) and the interface.
- Connect the OBD plug (blue contact protection) of the diagnostics cable to the machine's OBD contact (located behind the cover in the steering column).

With CAN-FOX interface PN 03502430 (*): (recommended Variant – see chapter 2.1.3)

Connect the D-Sub 9 connection of the diagnostics cable marked CAN1 (red marking) to the D-Sub 9 connection of the interface marked “CAN”.

Caution: Do not use the D-Sub 9 connection with the designation RS232.

2.1.2 Flashing the control unit

With CANUSB interface PN 03501750 (**): (Alternative connecting opportunity)

Connect the D-Sub 9 connection of the diagnostics cable marked CAN1 (red marking) to the round plug of the interface using the adapter piece (D-Sub 9 to 7-pole round plug) included in the scope of delivery of the diagnostics cable OBD II.

Flashing the software:

- Turn on the machine.
- Start the Hako diagnostics software. Select the “HAKO” button, then click the “CAN Flasher B75R / B120R” button. The application independently searches for a new, blank control unit.
- Follow the instructions of the programme. Do not turn off the machine or disconnect the connection before flashing has been completed.
- Carry out the settings for operative units, options, battery and parameters via the display according to the training documents.

2.1.3 Connection diagram

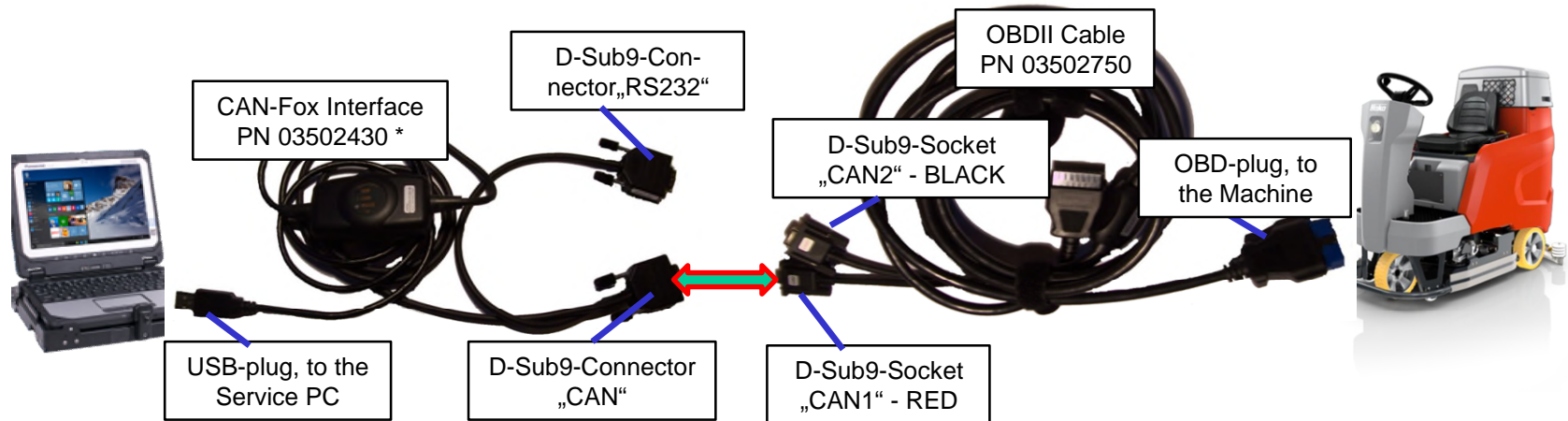

2.2 Brief description

Machine control takes place with the following electronics:

- Central electronics (A1)
- Control and display panel (A2)
- Drive control (A4)
- Chemical dosing (A101)

The control electronics (A1) assumes all control and monitoring tasks in the machine except for the drive functions.

In addition to the group messages of the drive control on the machine's display, these are shown as detailed flash codes using a flash LED. (see Chapter 9).

It is possible to toggle back and forth between the tip switches for scrubbing, vacuuming and the green Hakomatic button for combined cleaning, thus ensuring that the selected function is activated. When pressing tip switch "boost", the brush pressure is increased and the water quantity set to max. as long as the tip switch is pressed.

Tool operation can only be switched on if the parking brake is applied and the seat contact switch is open.

2.2.1 Switching off vacuuming / dirt water tank full

Vacuuming is switched off by the operator via the tip switch or automatically in case of the signal “dirt water tank full” to protect the suction turbine.

Switching off by the operator:

- The squeegee is raised.
- The suction motor switches off with a delay (15 seconds).

2.2.1 Switching off vacuuming / dirt water tank full

Switch off at recovery tank full:

The indicator switch for recovery tank full, is in the B120R a differential pressure sensor. As soon as the little ball in the filter sieve is lifted up by the water level and then sucked, the airflow to the suction motor is interrupted. This leads to different pressure levels at both connectors of the sensor, and the electric contact of the differential pressure sensor –B05 is closed. The differential pressure sensor is electrically connected to the main control unit –A01.X9:10 and –A01.X9:20.

The hose that is fitted to the connector marked with „P“ at the sensor, is connected with the borehole **T** in the lid. This end measures the pressure in the recovery tank. The other end of the differential pressure sensor is connected with the bohrhole **S**. This End is related to the intake of the suction motor.

The maximum tightening torque for the fixing screws of the sensor is 1,6Nm.

2.2.1 Switching off vacuuming / dirt water tank full

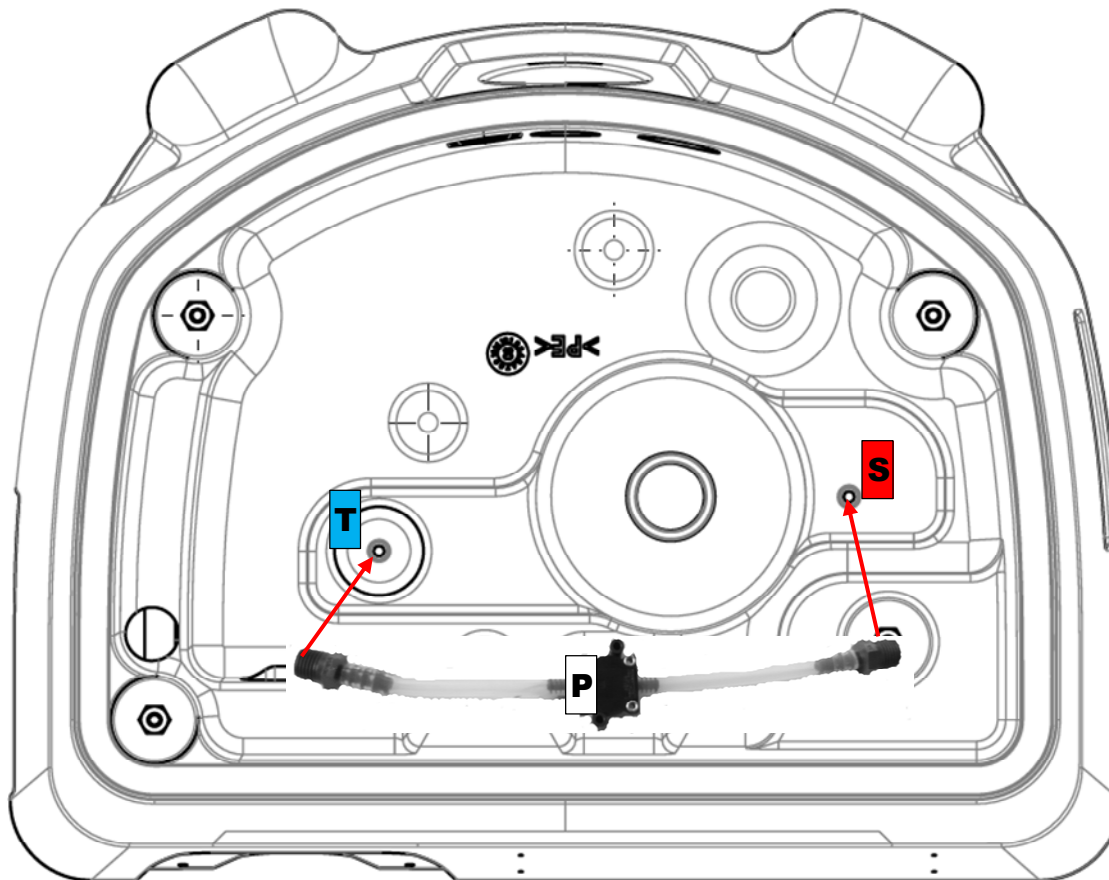

2.2.2 Indication Solution Tank empty

As soon, as a amount of approx. 10l water is left in the solution tank, the machine control system indicates it with a blinking water tap and a acoustical signal. This is determined by a float switch, that is positioned in the solution tang in the area above the right rear wheel. The float switch –B04 is connected at the main control unit at connector –A01.X9:6 and –A01.X9:16.

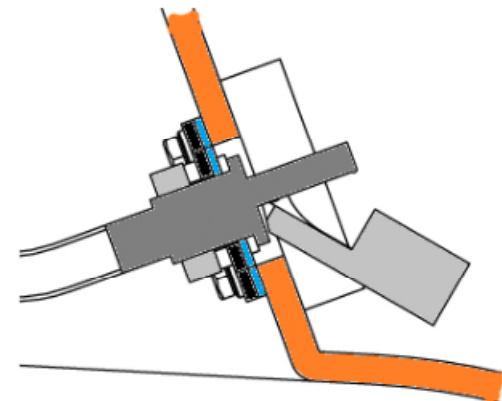

Position of the float switch –B04
in the solution tank

2.2.3 Machine home position

After turning on the machine, all components are set to “home position” if the seat contact switch is actuated (closed).

The lifting elements will be raised if they have not already been switched off via the micro-switch for the upper end position integrated in the lifting element (squeegee) or the upper end position is detected by the control unit via the integrated potentiometer. The motors are switched off and the LED indicators in the control panel for the cleaning components go out.

The lifting element for the brush head features integrated position detection via a potentiometer.

When removed, the spindle of the lifting element may not be twisted as otherwise the positioning of the lifting element is misaligned.

2.2.4 Seat contact switch (3.6.6.4.)

The seat contact switch (S05) is connected to the control electronics A1 at A1:X9.8+18 and A1:X9.3+13.

The control electronics (A1) responds to the relief of the seat with an approx. 2 second delay. This means: If the contact at A1:X9.8+18 is opened for longer than 2 seconds during machine operation, the motors stop and the brush head and the squeegee are raised.

If the switch is closed again within 2 seconds, the machine continues to operate without any interruptions.

If the seat contact switch is not actuated for > 6 hours while the key switch is switched on, the machine is locked in all functions (driving and cleaning). The same applies if both contacts of the seat contact switch have the same switch status for longer than a few seconds, i.e. both switches are detected as being open or closed by the machine (seat switch manipulation).

The service code 3.6.6.4. is shown in the operating hours meter. Only driving is now still possible. If the key switch is switched off and then back on without the seat contact switch being relieved or actuated again, the driving function is also deactivated.

2.2.4 Seat contact switch (3.6.6.4.)

To reactivate the machine after triggering “seat switch manipulation”, the machine control unit must “register” the change of the switch status or the change between ‘operator is sitting on the machine’ and ‘operator has left the seat’.

To achieve this, the seat contact switch must be opened and closed several times while the machine is on.

A seat contact switch that has been detected as being “open” by the machine (no operator on the seat) is indicated on the display of the control panel via the flashing hour indicator and the operator symbol. If the seat contact switch has been detected as being “closed”, i.e. an operator is on the seat, the hour indicator in the control panel is permanently on and the operator symbol goes out.

‘Seat contact switch closed’ means there is an operator on the seat;
Seat contact switch ‘**open**’ means there is **no** operator on the seat.

2.2.5 Accessing programming

The Scrubmaster B120R can be configured via the software and adapted to various options. The machine is also adapted to the different hardware (machine type, rotating brush head or roller brush head, batteries – LDS charger) via the software.

Changes to parameters not described in this manual can result in the machine malfunctioning. Therefore, all changes to the configuration must be carried out with utmost care.

Accessing the configuration menu

The procedure for accessing the configuration menu is described below:

- At first, connect diagnostics plug 0300 6790 to plug A1.X3 of the control electronics (Fig. 2.2). This is necessary for changing and saving parameters.

2.2.5 Accessing programming

Simultaneously press and hold tip switches 1 and 2 (Fig. 2.3) and switch on the key switch. The following display is shown in the operating hours meter after approx. 3 seconds:

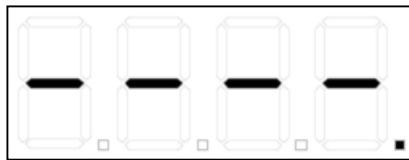

Figure 2.1

- You are now in the start menu of the configuration. Chapter 0 of the configuration menu is accessed by pressing tip switch 2.

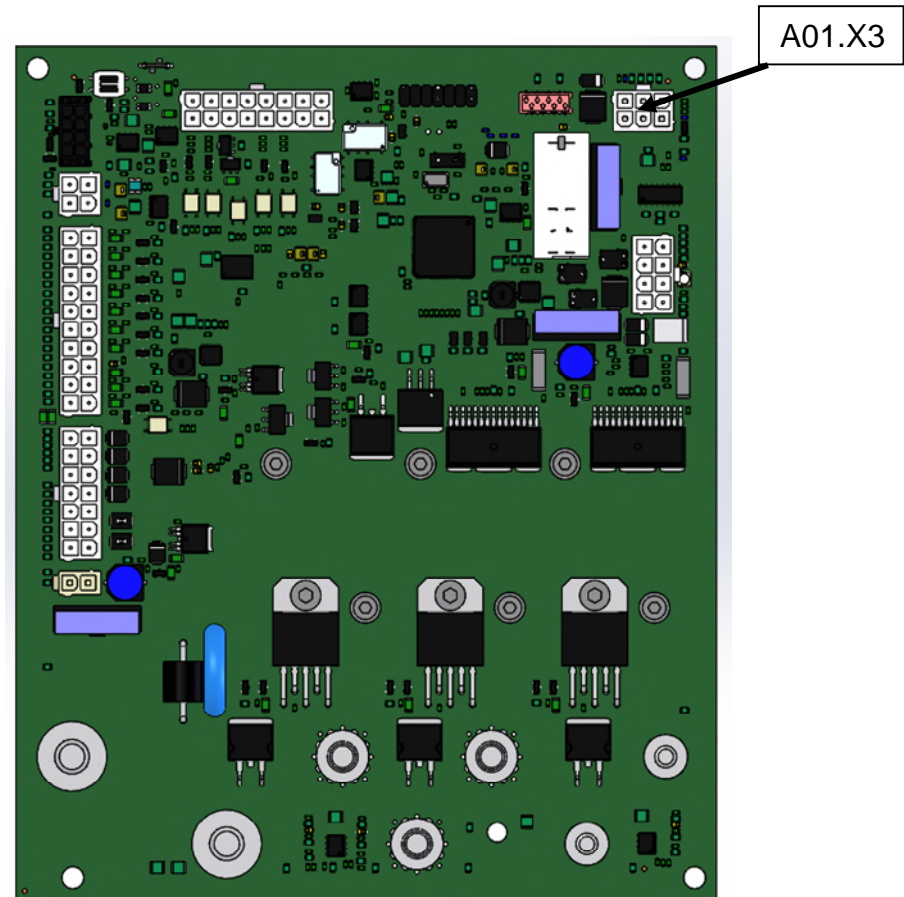

Figure 2.2

2.2.5 Accessing programming

Navigation in the configuration menu takes place using the three marked tip switches of the control panel. Tip switch 1 for “water+”; tip switch 2 for “water on/off”; tip switch 3 for “chemical dosing” (Fig. 2/3). The configuration menu is presented by three numbers (Fig. 2/4) which describe the individual levels. The left number describes the chapter, the middle number describes the configuration and the right number specifies the content. The number with a flashing dot to the right of it is the currently active level (chapter, configuration or content).

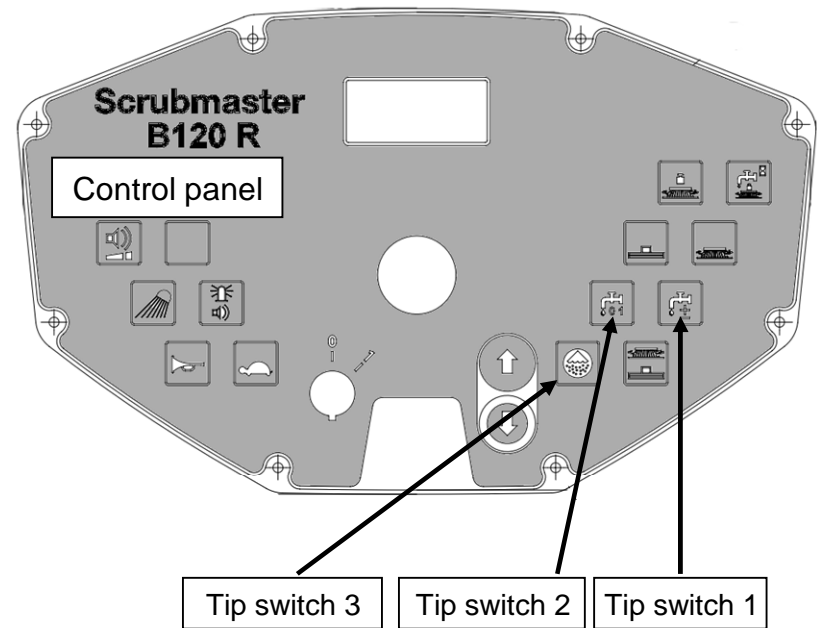

Figure 2.3

2.2.5 Accessing programming

The active level is changed by pressing tip switch 1:

Chapter -> Configuration -> Content -> Chapter

The value of the active level is increased by pressing tip switch 2.

Once the highest value has been reached, it is returned to the lowest value.

Pressing and holding tip switch 3 for at least 3 seconds saves the selected setting of the content if the diagnostics plug is connected to A1.X3.

The letter “d” in the parameter tables always means factory setting.

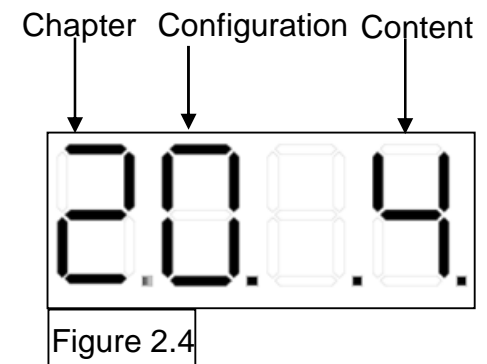

2.2.6 Resetting the last service message in the switch-on menu

Access to the programming level as described in Chapter 2.2.4. Figure 2.1 is displayed. The diagnostics plug must be connected to A1.X3 for changing parameters. Without the diagnostics plug, the parameters cannot be changed.

Press tip switch 2 six times to show the last occurred error on the display, e.g.



Press and hold tip switch 3 for approx. 3 seconds until “0.0.0.0.” is shown on the display. Use the key switch to turn off the machine and disconnect the diagnostics plug from A1.X3.

3 Technical data

Dimensions

Name	Unit	TB 750	TB 900	WB 700	WB 850
Length of machine with squeegee	mm	1675	1675	1675	1675
Width of machine with squeegee	mm	960	1120	960	1120
Width of machine without squeegee	mm	810	950	810	950
Height of machine	mm	1440	1440	1440	1440

Working width

Brush unit	mm	750	900	700	850
Squeegee	mm	950	1100	950	1100

Weights

Weight (empty, without batteries)	kg	340	355	324	326
Total weight (ready for use)	kg	723	738	707	709
Permissible total weight	kg	870	870	870	870

3 Technical data

Driving performance

Name	Unit	TB 750	TB 900	WB 700	WB 850
Driving speed transportation (forwards/reverse)	km/h	6.7/3.9	6.7/3.9	6.7/3.9	6.7/3.9
Climbing capacity when cleaning	%	2	2	2	2
Climbing capacity during transport journey (ready for operation, max. 1 minute)	%	10	10	10	10
Ramp angle/Slope angle	%	18	18	18	18
Turning circle (with squeegee)	mm	2470	2470	2470	2470

Wheels

Wheel diameter	mm	305	305	305	305
Specific wheel contact pressure front/rear	N/mm ²	0,49/ 0,48	0,49/ 0,48	0,49/ 0,48	0,49/ 0,48

3 Technical data

Tank contents

Name	Unit	TB 750	TB 900	WB 700	WB 850
Solution tank	Litre	120	120	120	120
Waste water tank	Litre	120	120	120	120

Brush head

Number of brushes	Piece	2	2	2	2
Brush speed	rpm	210	210	850	850
Min./Max. brush pressure	kg	37/60	50/70	26/33	28/35

Vacuum system

Air quantity	m ³ /h	110	118	110	118
Vacuum (maximum)	mbar	170	170	170	170

3 Technical data

Electrical system

Name	Unit	TB 750	TB 900	WB 700	WB 850
Nominal voltage	V	24	24	24	24
Nominal output (max.) (P1)	W	3260	3260	3100	3100
Power consumption drive motor (P1) S2-120 min	W	816	816	816	816
Power consumption vacuum motor (P1)	W	528	528	528	528
Power consumption brush motor (P1)	W	2x960	2x960	2x876	2x876
Power consumption water pump (P1)	W	100	100	100	100
Type of protection		IPX3	IPX3	IPX3	IPX3
Protection class		III	III	III	III

On-board charger

Rated input/output voltage	V	230/24	230/24	230/24	230/24
Nominal output	W	1130	1130	1130	1130
Type of protection		IP20	IP20	IP20	IP20
Protection class		I	I	I	I

3 Technical data

Noise emission value

The sound power level (L_{wAd}) measured under the customary conditions of use according to DIN EN 60335-2-72 is:	dB (A)	85
The sound pressure level (L_{pA}) (at the ear of the driver) measured under the customary conditions of use according to DIN EN 60335-2-72 is:	dB (A)	66
Measuring uncertainty (K_{pA})	dB (A)	2

Vibration

Under the customary conditions of use, the weighted effective value of the acceleration to which the upper limbs (hand-arm) are subjected to according to DIN EN ISO 5349 is:	m/s^2	≤ 2.5
Under the customary conditions of use, the weighted effective value of the acceleration to which the body (feet or seat surface) is subjected to DIN EN ISO 2631-1 is:	m/s^2	≤ 0.5

4. Maintenance intervals

The Hako system maintenance specifies in single modules the special technical work to be done and the periods of time for the maintenance activities.

Parts to be replaced for the individual maintenance tasks are determined.

Further details are also listed in the respective chapters.

4.1 Hako system maintenance (customer)

Maintenance must be carried out by the customer at the following maintenance intervals.

Activity / interval
Daily
<ul style="list-style-type: none"> • Empty the waste water tank, clean the waste water tank, drain hose, coarse dirt sieve (option) and suction filter
<ul style="list-style-type: none"> • Check the cover seal of the waste water tank, clean if necessary
<ul style="list-style-type: none"> • Check the battery, charge if necessary
<ul style="list-style-type: none"> • Check the squeegee, clean if necessary
Weekly
<ul style="list-style-type: none"> • Clean the machine as required
<ul style="list-style-type: none"> • Clean the solution tank
<ul style="list-style-type: none"> • Check the sieve insert in the fresh water filter, clean or replace if necessary
<ul style="list-style-type: none"> • Check the scrubbing performance of the brushes/pads, clean if necessary
<ul style="list-style-type: none"> • Check the brushes and water retaining ring for proper fit and wear, replace if necessary
<ul style="list-style-type: none"> • Check the suction performance of the squeegee, clean or replace the sealing strips if necessary
<ul style="list-style-type: none"> • Check the fresh water supply to the brushes, clean if necessary
<ul style="list-style-type: none"> • Check the drain hose for tight fit and damage, clean if necessary
<ul style="list-style-type: none"> • Check the rubber of the lateral wiper, replace if necessary
<ul style="list-style-type: none"> • Trial run and function test

4.2 Hako system maintenance I

Maintenance must be carried out by an authorised Hako service workshop at the following maintenance intervals.

Activity / interval
Every 250 hours
<ul style="list-style-type: none"> • Check the battery and the charger
<ul style="list-style-type: none"> • Check the battery acid level and acid density, refill demineralised water if necessary
<ul style="list-style-type: none"> • Check the air inlet grilles, air duct and filter mat of the on-board charger for contamination, clean or replace if necessary
<ul style="list-style-type: none"> • Check the steering pinion and gear rim for damage, replace if necessary. Lubricate as required.
<ul style="list-style-type: none"> • Check the brake for proper functioning
<ul style="list-style-type: none"> • Check the cover seal of the waste water tank, replace if necessary
<ul style="list-style-type: none"> • Check the seal at the drain hose, replace if necessary
<ul style="list-style-type: none"> • Check the leak tightness of the seal at the inspection cover, replace if necessary
<ul style="list-style-type: none"> • Check the sealing strip/slot strip of the squeegee, turn or replace if necessary
<ul style="list-style-type: none"> • Check the sieve insert and cover seal of the fresh water filter for damage, replace if necessary

4.2 Hako system maintenance I

Activity / interval
Every 250 hours
<ul style="list-style-type: none"> • Check the transparency of the level indicator hose, replace if necessary
<ul style="list-style-type: none"> • Check the rear wheel mounting screws, re-tighten if necessary (42 Nm)
<ul style="list-style-type: none"> • Check the condition of tyres
<ul style="list-style-type: none"> • Check the waste water and suction system, replace worn parts if necessary
<ul style="list-style-type: none"> • Check the fresh water supply, replace worn parts if necessary
<ul style="list-style-type: none"> • Check the electrical system (lighting, fuses and relays), replace parts if necessary
<ul style="list-style-type: none"> • Remove fluff and dirt from the air inlet grilles of the brush motors
<ul style="list-style-type: none"> • Check the squeegee setting, reset if necessary
<ul style="list-style-type: none"> • Check the front collision protection with deflecting roller for damage
<ul style="list-style-type: none"> • Check the hoses and connecting pieces to the differential pressure switch in the tank cap for contamination, clean or replace if necessary
<ul style="list-style-type: none"> • Check the optical condition of the machine (corrosion and labels)
<ul style="list-style-type: none"> • Trial run and function test

4.3 Hako system maintenance II

Maintenance must be carried out by an authorised Hako service workshop at the following maintenance intervals.

Activity / interval
Every 500 hours
<ul style="list-style-type: none">• All maintenance work according to Hako system maintenance I
<ul style="list-style-type: none">• Read the error memory and evaluate the error messages
<ul style="list-style-type: none">• Check electrical performance (drive motor, brush motor and suction turbine)
<ul style="list-style-type: none">• Replace the backup battery of the electrical control and set a real-time clock
<ul style="list-style-type: none">• Trial run and function test

4.4 Hako system maintenance S (safety check)

Maintenance must be carried out by an authorised Hako service workshop at the following maintenance intervals and at least once a year.

Activity / interval
Every 1000 hours
<ul style="list-style-type: none">• All maintenance work according to Hako system maintenance II
<ul style="list-style-type: none">• Remove coal dust from the brush motors and check the carbon brushes for ease of movement and wear, replace carbon brushes if necessary
<ul style="list-style-type: none">• Trial run and function test

5. Cleaning programmes (FPV)

The cleaning programmes are used to specify the behaviour of the water supply to the brushes, the brush motors in relation to the position of the driving direction switch and the drive potentiometer (forwards, neutral, reverse) as well as the squeegee.

A GND signal via XS11 is set to the input of the driving direction switch at A02.X6:4 via the drive potentiometer switch in B03. When driving direction 'forwards' is selected on the control panel, this signal is set from A02.X6:2 to inputs A01.X10:12 and A04.A1 via potential distributor XS04. When driving direction 'reverse' has been selected, the signal is set from A02.X6:3 to potential distributor XS05 and thus to inputs A01.X10:13 and A04.A2. If no GND signal is present at A01.X10:12 or 13, the cleaning units are not activated. If this signal is missing at A04.A1 or A2, the machine cannot be driven.

The behaviour of the cleaning functions is described in Table 5.1.

In order to select a cleaning programme, the programming level must be accessed as described in Chapter 2.2.4. The available cleaning programmes are listed in Table 5.2.

If the cleaning program is set to the value 3.0.0. (SOW program), further setting parameters from 3.1.x ...3.B.x are activated. Here, an own cleaning program can be compiled, in which the speed is reduced during scrubbing, during vacuuming and during scrubbing and vacuuming. The parameters are described in Table 5.3.

Press tip switch 3 for at least 3 seconds to save the programme change.

Subsequently, disconnect the diagnostics plug from A1.

5. Cleaning programmes (FPV)

Function	Content								
	1	2	3	4	5	6	7	8	9
Brush off when drive control is in neutral	Yes	Yes	Yes	Yes	Yes	Yes	Yes	Yes	Yes
Brush off when drive control is in reverse	No	No	Yes	No	No	Yes	No	Yes	No
Lift brush when drive control is in neutral	No	No	No	Yes	Yes	Yes	Yes	No	No
Lift brush when drive control is in reverse	No	No	No	No	No	Yes	No	No	No
Water off when drive control is in neutral	Yes	Yes	Yes	Yes	Yes	Yes	Yes	Yes	Yes
Water off when drive control is in reverse	No	Yes	Yes	No	Yes	Yes	Yes	Yes	No
Lift squeegee when drive control is in neutral	No	No	No	No	No	No	No	No	No
Lift squeegee when drive control is in reverse	No	Yes	Nein	Yes	No	No	Yes	Yes	Yes

Table 5.1

5. Cleaning programmes (FPV)

Chapter	Configuration	Content	Description	B120R
3	0		Adjusted FPV	0
3	0	0	SOW Variant (see Configuration 3.1...3.b)	X
3	0	1	Refer to FPV table	x
3	0	2	Refer to FPV table	d
3	0	3	Refer to FPV table	x
3	0	4	Refer to FPV table	x
3	0	5	Refer to FPV table	x
3	0	6	Refer to FPV table	x
3	0	7	Refer to FPV table	x
3	0	8	Refer to FPV table	x
3	0	9	Refer to FPV table	x

Table 5.2

5. Cleaning programmes (FPV)

Chapter	Configuration	Content	Description	B120R
			This Parameters are only visible, when the SOW-Menu 3.0.0 is activated.	
3	1		SOW: Brush off when drive control is in neutral	3
3	1	1	yes	X
3	2		SOW: Brush off when drive control is in reverse	1
3	2	0	no	X
3	2	1	yes	X
3	3		SOW: Lift brush when drive control is in neutral	1
3	3	0	no	X
3	3	1	yes	X
3	4		SOW: Lift brush when drive control is in reverse	1
3	4	0	no	X
3	4	1	yes	X
3	5		SOW: Water off when drive control is in neutral	3
3	5	1	yes	X
3	6		Water off when drive control is in reverse	1
3	6	0	no	X
3	6	1	yes	X

Table 5.3 a

5. Cleaning programmes (FPV)

Chapter	Configuration	Content	Description	B120R
			This Parameters are only visible, when the SOW-Menu 3.0.0 is activated.	
3	7		SOW: Lift squeegee when drive control is in neutral	1
3	7	0	no	x
3	7	1	yes	x
3	8		SOW: Lift squeegee when drive control is in reverse	1
3	8	0	no	x
3	8	1	yes	x
3	9		SOW: Reduce speed, when Brushes are on	1
3	9	0	no	x
3	9	1	yes	d
3	A		SOW: Reduce speed, when Suction is on	1
3	A	0	no	x
3	A	1	yes	d
3	B		SOW: Reduce speed, when Brushes and Suction is on	1
3	B	0	no	x
3	B	1	yes	d

Table 5.3 b

6. Machine settings

6.1 Basic settings

The machine series Scrubmaster B120R offers different equipment options and working widths. These can be set and adapted in the configuration menu. To check and change the setting, access the programming level as described in Chapter 2.2.4. The possible setting parameters are described in the following chapters.

6. Machine settings

6.1 Basic settings

6.1.1 Cleaning units

Four different brush units are used with the Scrubmaster B120R.

Two plate brush units with a working width of 75 cm or 90 cm; as well as two cylindrical brush units with a working width of 70 cm or 85 cm.

This setting is necessary for correct functioning of the overload limits and water quantities.

To check and change the setting of the cleaning units, access the programming level as described in Chapter 2.2.4. The possible setting parameters for the operative units are specified in Table 6.1.

6. Machine settings

6.1.1 Cleaning units

Chapter	Configuration	Content	Description	B120R
0	2		Brush decks	1
0	2	2	Plate brush deck 750mm	d
0	2	4	Plate brush deck 900mm	x
0	2	6	Cylindrical brush deck 700mm	x
0	2	7	Cylindrical brush deck 850mm	x
0	2	d	Adjustment for work with Pads ¹⁾	x

Table 6.1

1) Available on from Software revision 1.005

6. Machine settings

6.1.2 Battery and charger settings

In order to achieve optimum service life and performance of the batteries available for the machine, it is necessary to set the battery monitor, called LDS, and the charger to the correct battery type and capacity.

The internal measuring point for the LDS is at the power connectors of the machine control unit –A01.X1 and –A01.X2.

These settings are carried out in the menu items 0.3.X; 0.4.X and 0.5.X.

If the setting for a machine without charger (0.4.0), with charger and without communication (0.4.1) or for a charger with communication and free characteristic curve selection (0.4.2) is carried out in 0.4.x, the LDS must also be set correctly in 0.3.X.

With the charger settings 0.4.4; 0.4.6 and 0.4.7, the LDS setting takes place automatically via the battery selection in 0.5.X.

In this case chapter 0.3.X is not displayed in the configuration menu.

6. Machine settings

6.1.3 Battery setting (LDS)

GiS and GiV are batteries with grid type plates

PzS and PzV are batteries with tubular type plates

GiV and Pzv are encapsulated, absolutely maintenance-free gel batteries

GiS and PzS are sealed, low-maintenance batteries containing liquid electrolyte
Regular checking of the electrolyte as well as topping up cleaned water are required here.

AGM batteries have glass mat separators.

The following designations are also used for monobloc batteries:

GiS = FF

GiV = GF-Y; GF-V

PzS = FT

Trough batteries are available in the following versions:

EPzS / EPzB and EPzV



6. Machine settings

6.1.3 Battery setting (LDS)

Chapter	Configuration	Content	Description	B120R
0	3		TSG Adjustment - Battery-Type (only for 0.4.0; 0.4.1 and 0.4.2)	1
0	3	0	Crown w/o Offset	x
0	3	1	Crown	x
0	3	2	GIS, „Foreign“	x
0	3	3	GiS	x
0	3	4	PzS or PzB „Foreign“	x
0	3	5	PzS or PzB	d
0	3	6	GiV	x
0	3	7	PzV	x
0	3	8	AGM - only for Hoppecke batteries	x

Table 6.2

6. Machine settings

6.1.4 Charger

In this menu item (0.4.X), it is specified whether the machine features an integrated charger and whether this charger communicates with the machine control unit via CAN bus.

With chargers that communicate with the machine, there are various selection options. If the charger with free characteristic curve selection is selected, the correct characteristic curve must be determined using the charger documents and then set correctly under 0.5.X. The column under 0.4.2 in Table 6.4 then applies to this setting. When selecting the Gel-block batteries (GiV) (0.4.4), Gel-Trough-batteries (PzV) (0.4.6) or Wet-trough-batteries (PzS; PzB) (0.4.7), only the characteristic curves that are valid for these battery types and sizes are shown under 0.5.X (see Table 6.4 in the columns 0.4.4; 0.4.6 and 0.4.7)

To check and change the setting, access the programming level as described in Chapter 2.2.4. The possible setting parameters are specified in Table 6.4.

6. Machine settings

6.1.4 Charger

Chapter	Configuration	Content	Description	B120R
0	4		Battery charger and Battery types	1
0	4	0	w/o battery charger	x
0	4	1	battery charger w/o communication	x
0	4	2	Battery charger with communication (manual charging characteristics selection)-see battery charger manual	x
0	4	4	Battery charger with communication for GiV-batteries	x
0	4	6	Battery charger with communication for PzV-batteries	x
0	4	7	Battery charger with communication for PzS/PzB-batteries	d

Table 6.3

6. Machine settings

6.1.5 Charger characteristic curves

Chapter	Configuration	Content	Description				B120R
			for 0.4.2	for 0.4.4	for 0.4.6	for 0.4.7	
0	5		Charging characteristic / Battery size				1
0	5	0	LK0	--	--	--	x
0	5	1	LK1	180Ah GiV	--	--	x
0	5	2	LK2	240Ah GiV	--	240 Ah PzS	x
0	5	3	LK3	--	--	320Ah PzS	x
0	5	4	LK4	--	--	210Ah PzB	x
0	5	5	LK5	--	280Ah PzV	--	x
0	5	6	LK6	--	--	--	x
0	5	7	LK7	--	--	--	x
			LDS is automatically adjusted for this adjustments				

Table 6.4

6. Machine settings

6.1.6 Charging characteristics of the integrated charger

 Industrie
 ELEKTRONIK
 Brilon GmbH

 Kennlinientabelle – Hako
 Batterieladegerät 24V 35A

Filon Futur M

Typ: E 230 G 24/35 B45-FP

Programm	0 Werks- einstellung	1	2	3	4	5	6	7
Batteriespannung	24V	24V	24V	24V	24V	24V	12V	24V
HAKO-Batterie	320Ah PzS	210Ah PzB 240Ah PzS		280Ah PzV	240Ah GiV	180Ah GiV 170Ah AGM	105Ah GiV 115Ah AGM	105Ah GiV 115Ah AGM
Batterietyp	PzS	PzS 0PzB	PzS 0GiS	PzV	GiV	alle	alle	alle
Kapazität allgemein	320-400Ah	210-262Ah	170-212Ah	240-291Ah	240-291Ah	160-233Ah	100-125Ah	100-125Ah
Kennlinie	IUIola	IUIola	IUIola	IUIola	IUIoU	IUIoU	IUIoU	IUIoU
Ladevorschrift	Herstellervorgabe	Herstellervorgabe	Herstellervorgabe	Herstellervorgabe	Herstellervorgabe	IEB	IEB	IEB
Ladezeit	12h	8,5-9h	8h-9h	13h-14h	12h-13h	12h	8-12h	8-12h
Hauptladung I ₁	35,0A	33,6A	30,0A	35,0A	35,0A	28,0A	16,0A	16,0A
U ₁	28,8V	28,8V	28,8V	28,2V	28,2V	28,6V	14,3V	28,6V
t _{IC max} ¹⁾	10,5h	7h	7h	9h	9h	9h	9h	9h
t _{HL max} ²⁾	12h	10h	10h	12h	12h	12h	12h	12h
I _{um}	16,0A	10,5A	8,5A	3,2A	3,8A	di0dt	di0dt	di0dt
Nachladung I ₂	16,0A	10,5A	8,5A	3,2A	3,8A	2,1A-6,4A	1,3A-4,0A	1,3A-4,0A
U ₂	33,6V	33,6V	33,6V	33,6V	33,6V	33,6V	16,8V	33,6V
t _{NL}	1-4h 0,6 * t _{HL}	1-4h 0,6 * t _{HL}	1-4h 0,6 * t _{HL}	1-4h t _{NL} = t _{HL}	1-4h t _{NL} = t _{HL}	6h max du0dt	6h max du0dt	6h max du0dt
Ladeende I ₃	16,0A	10,5A	8,5A	1,6A	3,8A	2,5A	1,6A	1,6A
U ₃	33,6V	33,6V	33,6V	33,6V	27,6V	27,6V	13,8V	27,6V
t _{AUS}	8h ³⁾	8h ³⁾	8h ³⁾	12h	---	---	---	---
t _{Ein}	15min ³⁾	15min ³⁾	15min ³⁾	15h	unbegrenzt	unbegrenzt	unbegrenzt	unbegrenzt

¹⁾ Zwangsabschaltung / Fehlermeldung

²⁾ Zwangsumschaltung auf Nachladen (I₂)

³⁾ Zyklisch

Das Ladegerät startet die Ladung, wenn die Batteriespannung mindestens 0,2 V pro Zelle beträgt.

Unterhalb 1,5 V pro Zelle ist der Ladestrom auf 2A/100Ah begrenzt. Dauert diese Phase länger als 30min an, schaltet sich das Ladegerät mit einer Fehlermeldung ab.

HAKO#2435_1

6. Machine settings

6.2 Customer-specific settings (PPV)

Different settings can be carried out at the machine using the programmable programme variants.

It can, e.g., be set whether the last error that occurred in the machine is shown when turning on the machine or not.

To check and change the setting of the PPV, access the programming level as described in Chapter 2.2.4. The possible setting parameters are specified in the following table.

6. Machine settings

6.2 Customer-specific settings (PPV)

Chapter	Configuration	Content	Description	B120R
2	0		Last error indicator after switching on the machine	1
2	0	0	Deactivate	x
2	0	1	Activate	d
2	1		Water level when switching on scrubbing	0
2	1	0	Last setting	d
2	1	1	Preset level (4)	x
2	2		Water level when switching on scrubbing and vacuuming	0
2	2	0	Last setting	d
2	2	1	Preset level (4)	x

6. Machine settings

6.2 Customer-specific settings (PPV)

Chapter	Configuration	Content	Description	B120R
2	3		Water level when switching on TOOL (menu option only appears when TOOL option is activated!)	0
2	3	0	Last setting	d
2	3	1	Preset level (4)	x
2	6		Water Setting	0
2	6	0	From last level to first level (in circuit)	d
2	6	1	Change direction on reaching max./min. level (ping-pong)	x
2	7		Silence Mode Setting	0
2	7	0	Is not saved	x
2	7	1	Is saved	d

6. Machine settings

6.2 Customer-specific settings (PPV)

Chapter	Configuration	Content	Description	B120R
2	8		Acoustic Alarm Tone Interval (menu option only appears when the Acoustic Alarm option is activated!)	0
2	8	0	Standard	d
2	8	1	Alternative	x
2	B		Highest water stage independent from machine speed	0
2	B	0	Mo	d
2	B	1	Yes	x

7. Mechanical components

7.1 Squeegee

Squeegee connection

Carry out the pre-setting of the threaded bar for adjusting the squeegee inclination using the dimensions shown in Fig. 7.1 while making sure that the side with the fine thread (M10x1) faces the rear towards the squeegee.

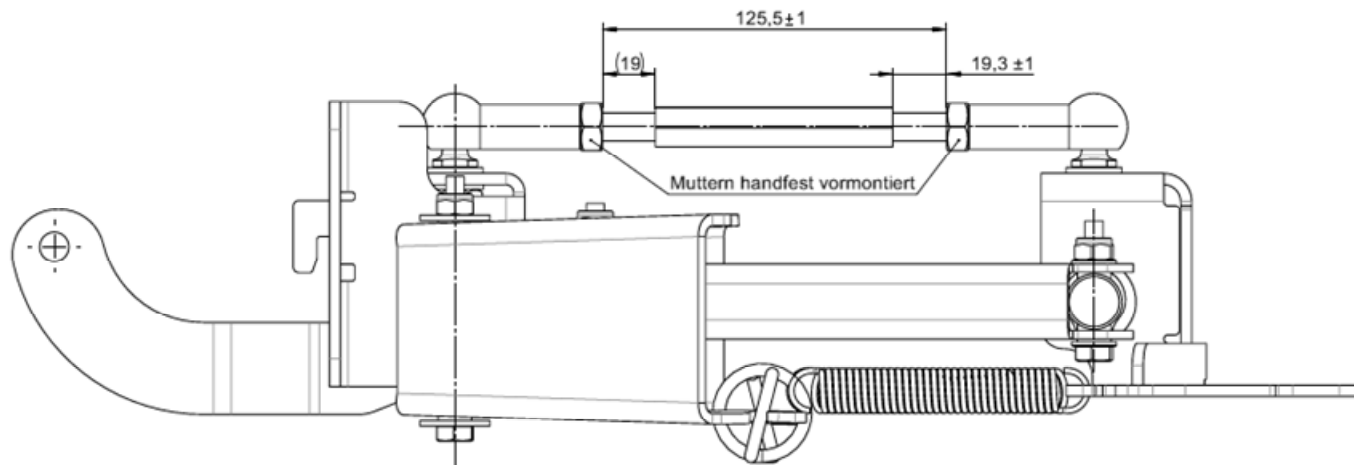

Figure 7.1

7. Mechanical components

7.1 Squeegee

Adjusting the sealing strips / inclination

The inclination adjustment decides whether the sealing strips of the squeegee are positioned evenly on the ground.

1. Place the machine on a level surface and lower the squeegee.
2. Loosen the lock nuts of the threaded bar (Fig. 7.2.a – A) and use the threaded bar (Fig. 7.2.a – B) to adjust the squeegee ensuring the ends of the sealing strips barely have contact with the ground.

Turn the threaded bar anti-clockwise: The distance of the sealing strip to the ground increases in the middle. (Fig. 7.2a)

Turn the threaded bar clockwise: The distance of the sealing strip to the ground decreases in the middle. (Fig. 7.2.b)

3. Turn on the machine and check the suction pattern. When driving, the sealing strips must be turned over evenly everywhere (centre and outside).
4. Tighten the lock nut of the adjusting screw to 7 Nm.

7. Mechanical components

7.1 Squeegee

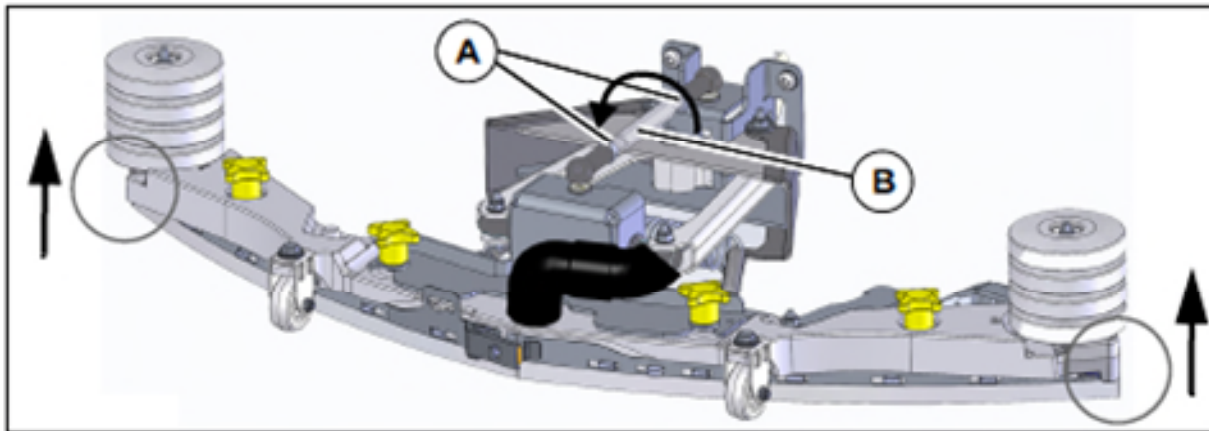

Fig. 7.2a

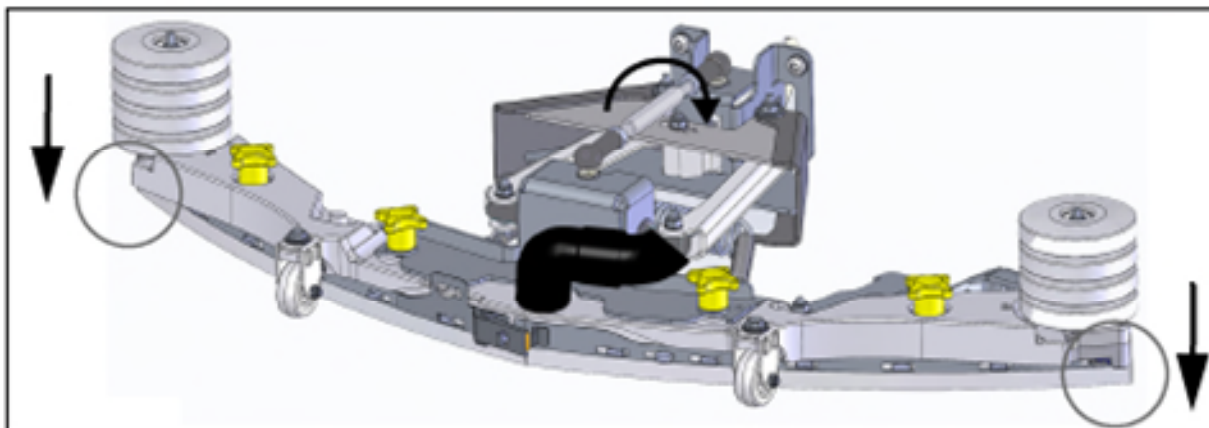

Fig. 7.2b

7. Mechanical components

7.1 Squeegee

Height adjustment

The height adjustment (X) of the supporting rollers Fig. 7.4 (A) has been set to 3 mm in the factory. If striping still occurs despite optimum inclination adjustment, set the distance of the supporting rollers to the lower edge of the sealing strip by adjusting the number of washers under the supporting roller holder.

Number of washers / distance to the ground (X)	Use
1/2 mm	Very smooth floor surfaces, e.g. coated screed, PVC, linoleum
2/3 mm	Standard setting
3/4 mm	Very uneven floor surfaces, e.g. poorly laid tiles (water does not drain off)

Figure 7.3

7. Mechanical components

7.1 Squeegee

Height adjustment

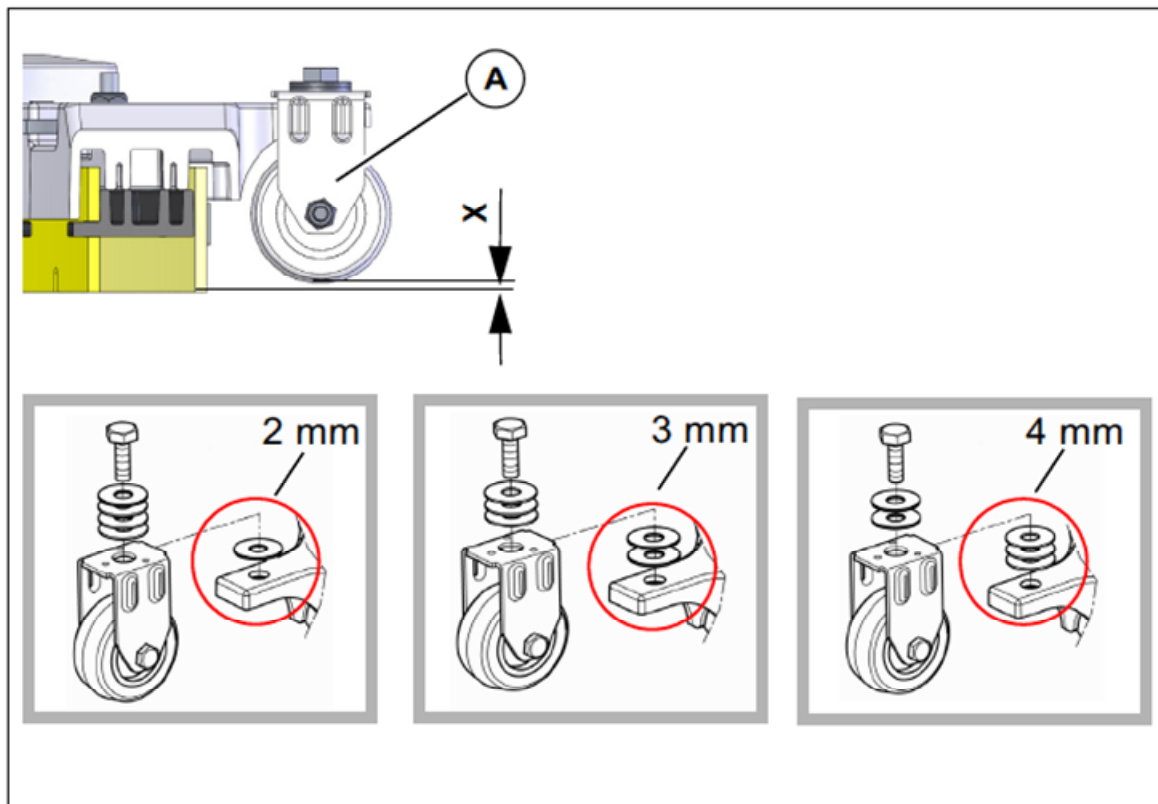

Figure 7.4

7. Mechanical components

7.2 Rotating brush heads

Rotating brush heads in two working widths (75 cm and 90 cm) are used with the Scrubmaster B120R.

Both brushes are driven by a separate motor.

7.3 Roller brush heads

Two working widths (70 cm and 85 cm) are available as roller brush units for the Scrubmaster B120R.

Use the guide rail to adjust the dirt hopper ensuring the brush strip is positioned all-round on the housing and the dirt hopper can still be slightly inserted.

7. Mechanical components

7.4 Lifting element brush head

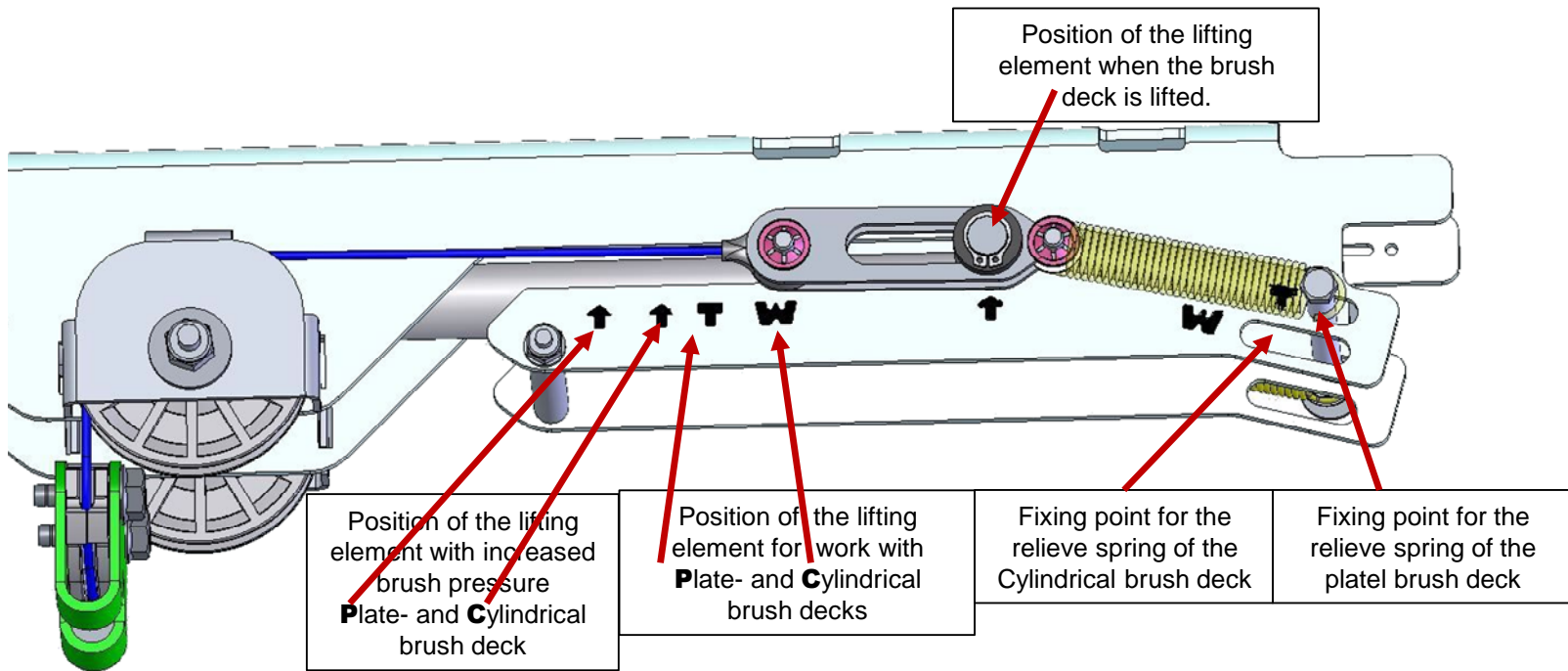

7. Mechanical components

7.4 Lifting element brush head

7.4.1 Potentiometer in the lifting element for the brush head

The lifting element for the brush head features integrated position detection. This position detection is supplied with 24 V via the machine's key switch. The reference signal for the position of the brush head can be measured at the central control unit at A01.X19:2 + 3.

Here, the position signal is at A01.X19:2 and the negative side of the positioning sensor at A01.X19:3.

The following values must be measured here (rotating brush unit):

Brush unit raised:	2.3 V
Brush unit in working position:	1.5 V
Brush unit with pressure reinforcement:	1.2 V
Boost function:	1.2 V

8. Water pump

The water pump for supplying the operative units is connected at the central control unit at A01.X11:4 + 11. It is operated via clocked voltage to convey different water quantities for the six stages. The voltage values measured here depend on numerous factors; it is therefore not possible to specify exact values. Decisive is that the voltage values differ considerably from the lowest to the highest stage.

The measurement of the water quantity is the recommended method to check the water supply.

8. Water pump

8.1 Water quantities

Measurement of the water quantities offers a good and reliable method to test correct functioning of the water pump. Let the pump run and measure the water quantity conveyed per minute. The water quantity for the plate brush units can be set from approx. 1.0 l to approx. 5.2 l. The setting range for the cylindrical brush units is from approx. 1.5 l to approx. 3.1 l.

Stage	1	2	3	4	5	6
Plate-brush	1,0	1,6	2,0	2,4	3,6	5,2
Cylindrical-brush	1,5	1,6	1,8	2,3	2,9	3,1

Water amount in l/min

If the pump is supplied with voltage but the water quantity does not correspond to the specifications, check whether hoses are clogged or bent, whether the solenoid valve opens fully and the diaphragms of the valve plate in the pump are in proper working order. The solenoid valve is connected at A01.X11:3 + 10.

8. Water pump

8.2 Water pump standstill detection

If the pump cannot convey freely because the water cannot run freely through the hoses to the brush, the so-called water pump standstill detection becomes effective.

Automatic water pump standstill detection:

The electronics offers the option to protect the water pump if the pump can no longer convey freely.

This means: If the pump sucks water from the tank but cannot further convey the water to the brushes, pressure builds up behind the pump. Without the protection through the electronics, the pump would now always pump against this pressure and could thus be damaged.

The electronics detects that the pump cannot convey freely and automatically switches the pump OFF for 2 seconds.

After these 2 seconds have expired, the pump is briefly switched back on while simultaneously measuring whether the pump can now convey freely again or whether the water supply to the brushes is still blocked.

If the pump can convey freely, it remains switched on in the selected stage.

If there is, however, still counter pressure, the pump is switched off again for 2 seconds.

This is repeated until the error has been eliminated.

8. Water pump

8.3 Speed depending water amount reduction

The machine has a reduction of the delivered water quantity, depending on the speed of the machine.

At speeds up to 30% v_{max} , the water quantity for stage 1 is delivered. Only at speeds from 75% v_{max} is the specified amount of water delivered.

The activated water quantity reduction is signaled in the display as a treadmill of the set water quantity.

In the PPV (chapter "2", configuration "B" – see chapter 6.2) you can define whether this speed-dependent reduction also applies to the highest water level or not.

This function is activated / deactivated by a long keystroke (>5s) on the key  with activated solution water supply.

9. Drive

The drive control features its own diagnostics and a self-test. Therefore, the function of the drive control is locked when turning on the machine if the drive potentiometer is in neutral or is not recognised as being in neutral.

The same behaviour applies after the seat contact switch has opened and is closed again.

The drive potentiometer must also be in neutral when closing the seat contact switch; or to be more precise: it must be recognised as being in neutral by the drive control.

If the drive control does not recognise that the drive potentiometer is in neutral, it shows flashing signals (LED) at the drive control. These messages are transferred to the machine control unit via CAN bus and evaluated by the machine control unit.

9. Drive

9.1 DMC drive control (AC motor)

The DMC drive control features a diagnostics input. Unless clearly noted in the service documents, changes to the preset values and parameters is generally **not** permitted. Currently, only the diagnostics with flash codes for the LED indicator is used.

9.1.1 Connection description:

M1; M2; M3 – motor connections

B+; B- – battery power supply

A – control connections (16-pole)

B – programming plug CAN bus (8-pole)

C – motor feedback (6-pole)
(encoder and temperature)

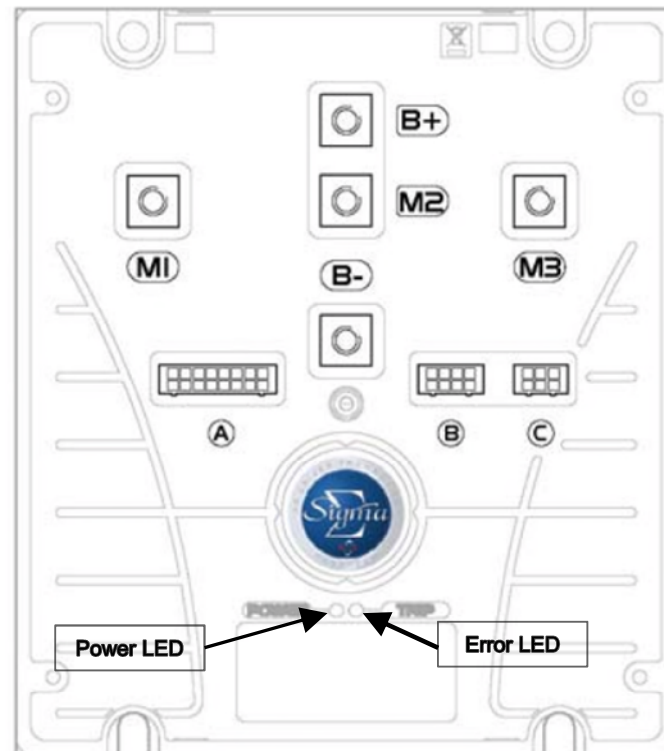

Figure 9.1

9. Drive

A1 – forwards (active when B- is connected) from A02:X6.2

A2 – reverse (active when B- is connected) from A02:X6.3

A3 – release for driving from drive potentiometer switch B03 (active when B- is connected)

A4 – release from machine control unit (seat contact) (active when B- is connected)

A5 – not used

A6 – not used

A7 – foot brake input from switch S10; if B- is connected, the machine is slowed down until standstill

A8 – supply speed control B03 (negative)

A9 – setpoint from speed control B03

A10 – control voltage from key switch

A11 – control power supply for small consumers (max. 3 A) (e.g. –K02, direction switch –A02:X6.1 and brake)

A12 – main relay release (B-) –K02 – power supply for drive control

A13 – brake release (B-)

A14 – not used

A15 – 12 V supply for encoder

A16 – 5 V supply for speed control B03

9. Drive

9.2 Service codes DMC control unit

Code	Name	Description	Remedy
Controller warning faults - Reduces only performance - Fault will reset itself (if possible)			
1	Not used	--	--
2	Low Voltage	Low Battery voltage (U < 18V)	Charge battery
3	Not used	--	--
4	High Voltage	High Battery Voltage (typically during braking) (U > 60V)	Defective Battery? Excessive downhill ride?
5	Drive Motor overheated	Machine is used outside it's specification?	Cool down the drive motor
6	Drive Control Unit overheated	Machine is used outside it's specification? Cooling of the Drive Control Unit ok?	Cool down the Drive Control Unit
7	Parameters out of specification	One or more parameters out of it's specification	Replace the Drive Control Unit
8	First Power Up	Default parameters restored in FRAM	If permanent error, replace Drive Control Unit

9. Drive

9.2 Service codes DMC control unit

Code	Name	Description	Remedy
Drive error faults -Commences gracefull neutral brake - requires a neutral recycle action to reset fault			
9	Memory chip fault	Memory not accessible	Internal voltage <12V; replace Drive Control Unit
10	2 directions active	forward and Reverse direction active	Check the wiring of the direction switch (-A02.X6 and -A04.A1/A2)
11	Seat switch not closed or timed out	No release signal from Machine Control Unit	Check the wiring from -A01.X10:2 to -A04.A4 (should be connected to battery minus)
12	Wrong Power Up sequence	Forward, Reverse or FS1 (-A04.A3) active before key switch on	Pay attention to the starting sequence: key switch / seat switch, direction switch, potentiometer switch.
13	Accelerator signal is active at Power Up	Speed signal is >50% at power up	Check the wiring between -A02.X6 and -A04.A1/A2
14	CAN-Bus	Stop via CAN	Machine Control unit send Stop Signal via CAN-Bus

9. Drive

9.2 Service codes DMC control unit

Code	Name	Description	Remedy
Soft error faults - immediately stops pulsing - Requires a neutral recycle action to reset fault			
15	Low voltage	internal 12V supply too low	Check charging level of the battery
16	Not used	--	--
17	Low voltage	Battery voltage too low	Check charging level of the battery
18	High Side Mosfet short circuit	Short circuit to battery plus	Check Motor insulating; Faulty Drive Control Unit.
19	Not used	--	--

9. Drive

9.2 Service codes DMC control unit

Code	Name	Description	Remedy
Hard Error Faults - Immediately stops pulsing and open line contactor - Cannot be reset (only by a key switch recycle)			
20	Hardware over current trip	Motor Over current	Check Motor and Motor wiring
21	Contactor Coil driver fault	Coil of Line Contactor or Magnetic Brake short circuit	Check Line contactor (-K02) and Magnetic Brake(-M01)
22	Battery Voltage is too high	Voltage > 67V	Excessive downhill ride?
23	Mosfet short circuit in neutral	Low side Mosfet short circuit in neutral position	Check Motor Insulation, if OK, replace drive Control Unit
24	Hardware Fail safe fault	Hardware safety problem	Check wiring. Replace Drive Control Unit.
25	Line Contactor failure	Relais Contacts are not closed within it's time Specification	Check the wiring of the line contactor (-K02) Battery Voltage too low? E-stop in Key switch circuit is active Open circuit from B+ to B- (Fuse -F04)
26	Faulty current measuring	Current measuring circuit defect	Replace the Drive Control Unit

9. Drive

9.2 Service codes DMC control unit

Code	Name	Description	Remedy
Hard Error Faults - Immediately stops pulsing and open line contactor - Cannot be reset (only by a key switch recycle)			
27	Mosfet shortcircuited to battery minus	Mosfet shortcircuited to battery minus before Line Contactor is closed	More than one motor phase has no connection to the drive unit. Check insulating of the motor. If ok, replace the Drive Control Unit
28 S01	Wire off	Motor Phase Connection	Check Wiring -A04 <=> -M01 Connection of one motor phase is interrupted.
28 S02	Wire off	Magnetic Brake short circuit	Check Wiring
28 S03	Wire off	Magnetic Brake wire off	Check Wiring
28 S04	Wire off	Speed sensor wire off	Check Wiring
28 S05	Wire off	Accelerator Wire off	Check Wiring of Hall Sensor -B03
28 S06	Wire off	Motor Thermistor Wire off	Check Wiring
29	CAN Error Front	CAN-Communication interrupted	Check CAN wiring, insufficient control voltage
30	Overspeed	Overspeed or speed sensor fault	Check parameters of the speed sensor

9. Drive

9.3 Brake – manual release of the brake

In order to also move the machine without power supply (no battery installed or other problems with the drive), the magnetic brake can be unlocked manually.

In order to push the machine, carry out the following steps:

1. Loosen the bolts of the cover to the drive using the supplied socket wrench and remove the cover.
2. Remove the pin **Fig. 9.2-A** from the holder and screw it into the ring **Fig. 9.2-B**.
3. In order to unlock the parking brake, slightly pull the pin upwards **Fig. 9.2-C** and simultaneously push the machine.
4. Disassembly is in reverse order.

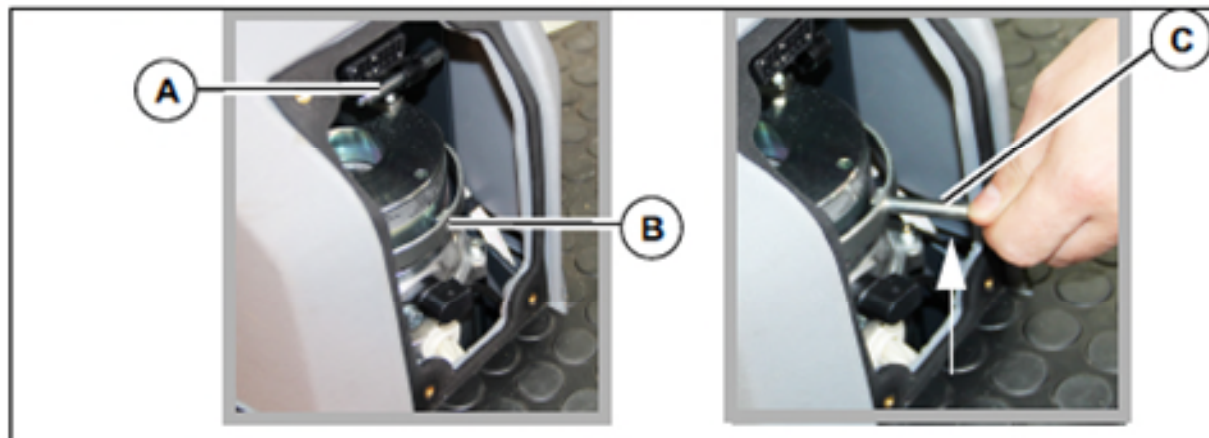

Figure 9.2

9. Drive

9.4 Brake – testing the brake function

The SCM B120R is equipped with a parking brake, which is an electromechanical brake located on the drive motor.

In normal working mode, the machine is braked via the travel drive control unit. Normal deceleration occurs when the drive pedal is released.

A stronger deceleration occurs when the brake pedal is pressed.

The brake must be capable of stopping the machine on a level road within 0.19 m per km/h. At a maximum speed of 6.5 km/h, this means that the maximum braking distance must not exceed 1.235 m. Check this after carrying out work at the brake system and as part of regular maintenance.

This value must be achieved when actuating the brake tip switch S10.

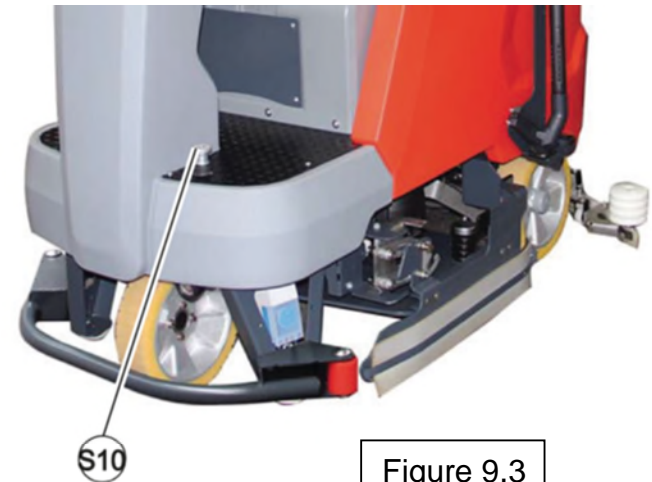

Figure 9.3

10. Service messages

Service-Code	Description	Remedy
1.2.2.1.	Output Brush motor Semiconductor failure or short circuit to battery plus	Check brush motors and it's wiring
1.2.5.2.	Thermo switches brush motors	Check current consumption of brush motors and wiring of the thermo switches
1.2.6.1.	Brush motors over current or short circuit	Short circuit in the brushmotors or in their wiring
1.2.6.3.	Lifting element brush deck	Overload of the brush deck lifting element
1.4.2.1.	Output suction motor Semiconductor failure or short circuit to battery plus	Check suction motor and it's wiring
1.4.6.1.	Lifting element squeegee	Overload of the squeegee deck lifting element
1.4.6.3.	Suction motor over current or short circuit	Short circuit in the suction motor or in it's wiring

10. Service messages

Service-Code	Description	Remedy
1.5.4.1.	Malfunction water valve	Water valve over current, interruption in the wiring or short circuit to battery plus
1.7.4.1.	Chemical dosing agent problems	Chemical dosing agent over current, interruption in the wiring
3.1.1.2.	Fleetrekorder communication interruption	Check wiring between machine control unit and Fleetrekorder
3.1.1.d.	Battery charger communication to machine control unit interrupted	Check wiring between -G10.X7 and -A01.X4
3.1.6.E	Powersupply at X1 of the machine control unit is interrupted or insufficient.	Check the voltage at -A01.X1 / X2. This voltage value has to be identical with the battery voltage. Check the power contacts of -K04 and fuse -F03 (125A)
3.2.6.5.	Backup battery weak	Replace backup battery; Type CR2032
3.2.6.6.	Backup battery empty	Replace backup battery; Type CR2032

10. Service messages

Service-Code	Description	Remedy
3.3.1.1.	Service intervall expired	Reset the service intervall with the Hako diagnosis
3.3.4.1.	Malfunction in the buzzer -P02	Over current or interrupted wiring
3.3.8.1.	Malfunction drive control unit; Magnetic brake short circuit or interrupted wiring	Check the magnetic brake and it's wiring
3.4.0.1.	Malfunction drive control unit; interrupted wiring encoder	Check the wiring of the encoder
3.4.1.1.	Malfunction drive control unit; pre selection of driving direction implausibly or interrupted wiring accelerator	Check wiring of the accelerator -B03
3.4.1.2.	Internal error drive control unit	Replace the drive control unit
3.4.1.3.	Malfunction drive control unit	See blinking code at the drive control unit

10. Service messages

Service-Code	Description	Remedy
3.4.2.1.	Interruption power wiring drive motor	Check the wiring of the drive motor
3.4.5.1.	Malfunction drive control unit; over temperature drive motor or drive control unit, interrupted wiring thermo switch drive motor	See blinking code at the drive control unit; check the wiring of the drive motor thermo switch. Is the machine used outside it's specification?
3.5.4.1.	Working head light over current or interrupted wiring	Check the wiring at output -A01.X16:1 + 2 for short circuit and interruption
3.5.4.2.	Warning beacon over current or interrupted wiring	Check the wiring of the warning beacon (-E02; -E03)
3.6.6.4.	Seat contact switch manipulation	See chapter 2.2.3.
4.1.2.1.	Communication problem drive control unit	CAN-Bus-error between machine control unit and drive control unit
4.1.3.1.	Communication problem drive control unit	See blinking code at the drive control unit

10. Service messages

Service-Code	Description	Remedy
4.5.2.5.	Display communication problems (Display not recognized)	Communication between display and control unit interrupted (message is generated by the display)
4.5.3.5.	Display communicatin problems (Timeout)	Communication between display and control unit interrupted (message is generated by the display)
4.6.1.3.	Internal malfunction of machine control unit	Replace the control unit
5.8.7.1.	Malfunction battey charger - charger related problems. Malfunction nos. 06; 07; 08; 09; 10; 11; 12; 13; 14; 15	See battery charger manual
5.8.7.2.	Malfunction battey charger - battery related problems. Malfunction nos. 01; 02; 03; 04 oder 05	See battery charger manual
7.1.2.5.	Malfunction drive control unit; problems of power supply (over- / under- voltage) or problems in current measuring unit	See blinking code at the drive control unit

10.1 Service alarm clock – 3.3.1.1

The service alarm clock is set via the Hako diagnostics system.

11 Battery charger

11.1 Operating manual



Operating Instruction

page: 1
of: 2

Hako GmbH
D-23843 Bad Oldesloe
Hamburger Straße 209-239
Telephone: (04531) 806-0

Battery Charger
Type: E230 G 24/35 B45-FPO
Hako-order no.: 92003284

Date	Rev.-No.
10.03.2017	1

Controlled battery charger for lead batteries with liquid and solid electrolyte in SNT technology

**controlled backup charging – reverse battery protection –
protection against short circuit – constant conservation of charge –
low AC-current**

General information

The housing of the battery charger is made of enclosed sheet metal steel.

The mains connection is made via a special mains connection cable.

Mains fuse (F1): Micro fuse 5x20 mm. Back-up only through value resembles T 6,3 AH 250V.

The battery charger is protected against short circuits and equipped with a reverse battery protection.

The operating status can be indicated with an external/separate LCD-display and LEDs.

The battery charger should only be opened by qualified personnel.

The charger is especially designed for cleaning machines of the type Scrubmaster B120R and has to be used only in combination with these machines.

Attention: Non-rechargeable batteries can not be charged with this battery charger.

11 Battery charger

11.1 Operating manual

Initial operation

At first it has to be checked, if the pre-set battery type is appropriate to the used battery (customer service).

The mains connection (120-230V AC, 50-60Hz) has to be implemented with a delay-action fuse.

The charger is connected to the mains with the mains plug.

To charge the battery, follow the instructions of the battery manufacturer!

Important note:

Before using a battery for the first time, there has to be done an initial operation charge (please see also battery manual). This is accomplished by doing a regular charge process. Only after the charging-cycle has been fully completed with "end of charge"-indication, the machine can be used. For maintenance-free PzV-batteries an additional 15h compensator-charge is recommended.

Sequence of connection:

The charger has to be disconnected from the mains supply before connecting/disconnecting the charging plug/cables to the battery.

The battery charger complies with the protection regulations of the low voltage guideline 2006/95/EEC and the guideline for electromagnetic compatibility 2004/108/EC.



EN 60 335-1
EN 60 335-2-29

11 Battery charger

11.1 Operating manual





Operating Instruction

page: 2
of: 2



Hako GmbH
D-23843 Bad Oldesloe
Hamburger Straße 209-239
Telephone: (04531) 806-0

Functional description and monitoring of charging process

The battery charger begins to charge automatically, if the mains power and the battery connection have been properly connected.

With begin of the charging the battery connection is checked and all LED's light up briefly. During the main charge the 1st and 2nd charge icon  light up successively. When the pre-stored gassing voltage has been reached, this voltage will be stabilized and the current drops slowly (U_{constant}). After the current has reached a constant phase, the charger switches over to backup-charging and the 3rd charge icon  lights up, too. After the backup-charge has been completed, the charging electronic switch device changes to end of charging/constant conservation of charge. All four charge icons  light up.

Do not interrupt the charging procedure until battery is adequately charged. An interruption may cause a loss of capacity and premature failure of the battery. The driving-off protection is a potential-free contact preventing the use of the vehicle during the charging process.

To pause the charging, press the push-button short. In this charge state the charge plug can be disconnected. The 2nd and the 4th icon  are blinking alternating with the 3rd charge icon . To continue the charging, press the push button short or wait 1 minute.

“Battery not connected” is indicated by the blinking icon and is detected immediately when switching on the battery charger during operation and during the latest 60 sec. after disconnecting the battery.







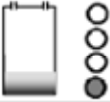
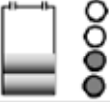

Please make sure that there is no reverse connection of the battery during this time!

When the battery is connected again, the charging set switches itself on.

11 Battery charger

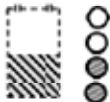
11.1 Operating manual

Indication of operating status by the external display and LEDs

operating status	LCD-/LED-indicator					malfunction number
						
Main charge $V_{bat} < 2V/C$	X					
Main charge		X				
Backup charge			X			
Conservation charge				X		
operating status during malfunction*						
Battery malfunction	X					1
Battery voltage too high		X				2
Time malfunction			X			3..4
Control malfunction				X		11..13
Temperature malfunction					X	6

* If there is a malfunction, the frame and lower icon/under LED flashes once a second.

Safety function of the electronic charging switch device according to the malfunction number

- | | |
|---|---|
| 1. battery missing, reverse connection or $V_{bat} < 0,2 V/C$ | 4. constant current phase too long |
| 2. during start-up the battery voltage is $> 2,4 V/C$
(under 2.40 V/C the charger switches on automatically) | 6. temperature in the charger is too high |
| 3. battery voltage $< 1,5 V/C$ for longer than 40 minutes | 11-13. control malfunction |

11 Battery charger

11.2 Programming the charger

The integrated Battery charger is adjusted to the different batteries only via the machine control unit. (see chapter 6.1.4 and 6.1.5)

11 Battery charger

11.3 Charge data table

 Industrie
 ELEKTRONIK
 Brilon GmbH

Kennlinientabelle – Hako

Batterieladegerät 24V 35A

Filon Futur M

Typ: E 230 G 24/35 B45-FP

Programm	0 Werks- einstellung	1	2	3	4	5	6	7
Batteriespannung	24V	24V	24V	24V	24V	24V	12V	24V
HAKO-Batterie	320Ah PzS	210Ah PzB 240Ah PzS		280Ah PzV	240Ah GiV	180Ah GiV 170Ah AGM	105Ah GiV 115Ah AGM	105Ah GiV 115Ah AGM
Batterietyp	PzS	PzS 0PzB	PzS 0GiS	PzV	GiV	alle	alle	alle
Kapazität allgemein	320-400Ah	210-262Ah	170-212Ah	240-291Ah	240-291Ah	160-233Ah	100-125Ah	100-125Ah
Kennlinie	IUIoIa	IUIoIa	IUIoIa	IUIoIa	IUIoU	IUIoU	IUIoU	IUIoU
Ladevorschrift	Herstellervorgabe	Herstellervorgabe	Herstellervorgabe	Herstellervorgabe	Herstellervorgabe	IEB	IEB	IEB
Ladezeit	12h	8,5-9h	8h-9h	13h-14h	12h-13h	12h	8-12h	8-12h
Hauptladung I ₁	35,0A	33,6A	30,0A	35,0A	35,0A	28,0A	16,0A	16,0A
U ₁	28,8V	28,8V	28,8V	28,2V	28,2V	28,6V	14,3V	28,6V
t _{ic max} ¹⁾	10,5h	7h	7h	9h	9h	9h	9h	9h
t _{HLmax} ²⁾	12h	10h	10h	12h	12h	12h	12h	12h
I _{um}	16,0A	10,5A	8,5A	3,2A	3,8A	di0dt	di0dt	di0dt
Nachladung I ₂	16,0A	10,5A	8,5A	3,2A	3,8A	2,1A-6,4A	1,3A-4,0A	1,3A-4,0A
U ₂	33,6V	33,6V	33,6V	33,6V	33,6V	33,6V	16,8V	33,6V
t _{NL}	1-4h 0,6 * t _{HL}	1-4h 0,6 * t _{HL}	1-4h 0,6 * t _{HL}	1-4h t _{NL} = t _{HL}	1-4h t _{NL} = t _{HL}	6h max du0dt	6h max du0dt	6h max du0dt
Ladeende I ₃	16,0A	10,5A	8,5A	1,6A	3,8A	2,5A	1,6A	1,6A
U ₃	33,6V	33,6V	33,6V	33,6V	27,6V	27,6V	13,8V	27,6V
t _{Aus}	8h ³⁾	8h ³⁾	8h ³⁾	12h	---	---	---	---
t _{Ein}	15min ³⁾	15min ³⁾	15min ³⁾	15h	unbegrenzt	unbegrenzt	unbegrenzt	unbegrenzt

¹⁾ Zwangsabschaltung / Fehlermeldung

²⁾ Zwangsumschaltung auf Nachladen (I₂)

³⁾ Zyklisch

Das Ladegerät startet die Ladung, wenn die Batteriespannung mindestens 0,2 V pro Zelle beträgt.

Unterhalb 1,5 V pro Zelle ist der Ladestrom auf 2A/100Ah begrenzt. Dauert diese Phase länger als 30min an, schaltet sich das Ladegerät mit einer Fehlermeldung ab.

HAKO#2435_1

12. Options

Both factory and field options are available for the Scrubmaster B120R series. The factory options are only available for new machines ex factory. The field options can be retrofitted in the machines.

The parameters for the options that require a release via the machine's control system are specified in Table 12.1.

These options include:

- Acoustic warning signal
- Chemical dosing
- Scrubbing-vacuuming tool
- Working light
- Fleet-Recorder
- Sprinkle Nozzle

To set and check these values, access the programming level as described in Chapter 2.2.4 and enable the options.

The “silence kit” is the standard setting in all machines.

The mechanical installation of the field options is described in the related manuals, delivered with this field options.

12. Options

Chapter	Configuration	Content	Description	B120R
1	0		Silence-Kit	1
1	0	0	not available	x
1	0	1	available	d
1	1		Warning Signal (Optical and acoustical) (Front, Rear and Beacon on Pole)	1
1	1	0	not available	d
1	1	1	available	x
1	2		Chemical Dosing Agent	1
1	2	0	not available	d
1	2	1	available	x
1	3		TOOL	1
1	3	0	not available	d
1	3	1	available	x

12. Options

Chapter	Configuration	Content	Description	B120R
1	6		Working Headlight	1
1	6	0	not available	d
1	6	1	available	x
1	7		Fleetreorder	1
1	7	0	not available	d
1	7	1	available	x
1	B		TOOL - Spinkle Nozzle (for cleaning of the recovery tank)	1
1	B	0	not available	d
1	B	1	available	x

13. Real-time clock (RTC)

The Scrubmaster B120R features a real-time clock integrated in the machine's control system. When the machine is turned off, this clock is supplied with voltage via a backup battery on the control electronics.

Proceed as follows to set the clock, e.g. after replacing a battery:

- Connect diagnostics plug PN 03006790 to plug –A01.X3 (Fig. 2.2). Without the diagnostics plug, the date and time can only be displayed but not changed.

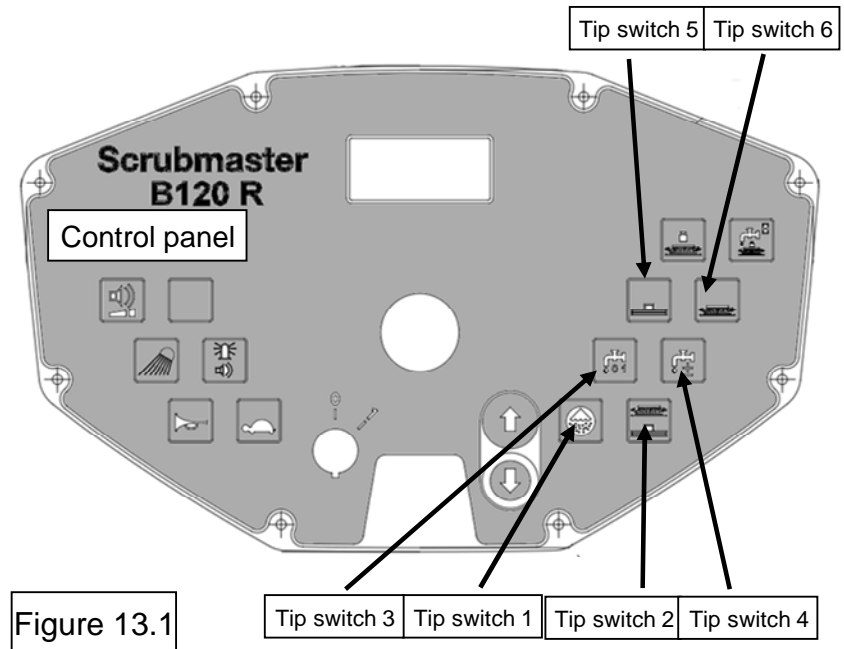

Figure 13.1

13. Real-time clock (RTC)

- To access the options menu, press and hold tip switches 1 and 2 simultaneously while the key switch is switched on. The display for the year is shown in the operating hours meter after approx. 3 seconds. (In the example: 11 for 2011). Now release the tip switches again.
- Press tip switch 6 to access the settings for month, day, hour, minute and second and subsequently return to year. The example shows 9 May 2011 at 11:05:25

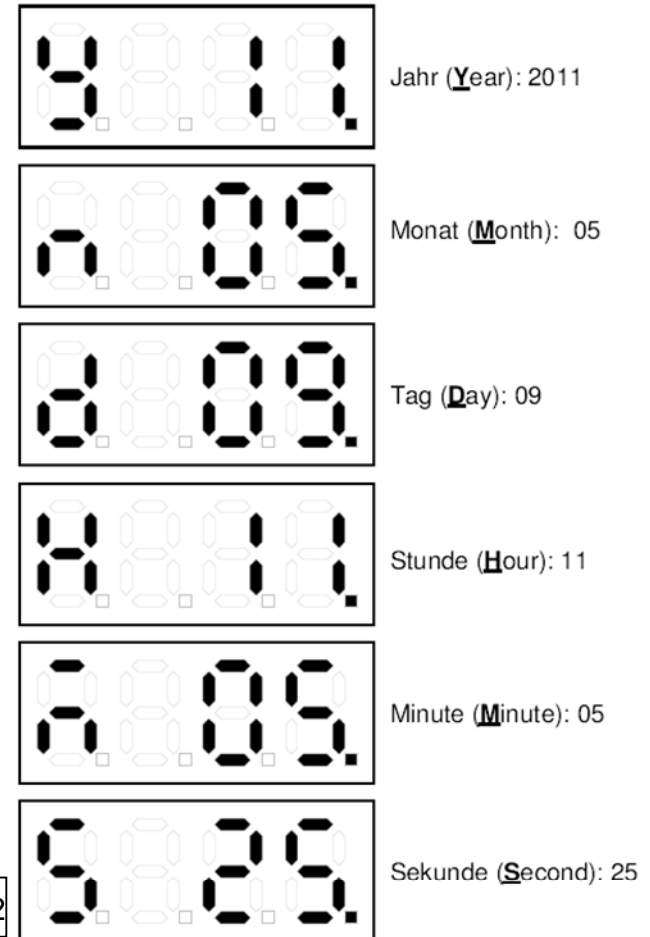

Figure 13.2

13. Real-time clock (RTC)

- The respective value in the display can be increased and reduced by pressing tip switch 4 and tip switch 3 respectively. If the respective tip switch is pressed and held longer than one second, the value automatically changes at constant speed.
- If a value is changed, the bottom right dot behind the last number disappears.
- After pressing tip switch 5 for 3 seconds, the changed value is saved and the bottom right dot behind the last number reappears.
- Exit the menu by turning off the machine.
- The settings can also be carried out via the Hako diagnostics system.

14. Notes

14. Notes

14. Notes